



DE/EN 09/19



CS-FLATLINER

CURTAIN-SIDER-VERDECK · CURTAIN-SIDER ROOF





Der SESAM CS-Flatliner ist für besonders hohe seitliche Durchladung geeignet *The SESAM CS Flatliner is suitable for particularly high side loading*

Ideale Raumnutzung · *Ideal use of space*

- Extrem flache Aluminiumschiene, damit die Ladehöhe von den Seiten maximiert wird.
Extreme flat aluminium track so that the loading height from the sides is maximized.
- Empfohlen für Kraftfahrzeuge, Anhänger und Container wegen der maximalen Länge von 11 Metern.
Suitable for motorvehicles, trailers and containers because of the maximum length of 11 metres.
- Perfekt für robuste Volumen-Gliederzüge
Perfect for robust volume-articulated trains
- Ideal für Getränke-Logistiker · *Ideal for beverage logistics*



Leicht und stabil · *Light and solid*

- Dieser Träger ist einzigartig simpel und funktionell
This carrier is uniquely simple and functional
- Hohe Seitensteifigkeit · High lateral stiffness
- Macht in vielen Fällen eine teure und auffällige Hubanlage überflüssig
Often eliminates the need for an expensive lifting system
- Einfache Montage · *Easy construction*

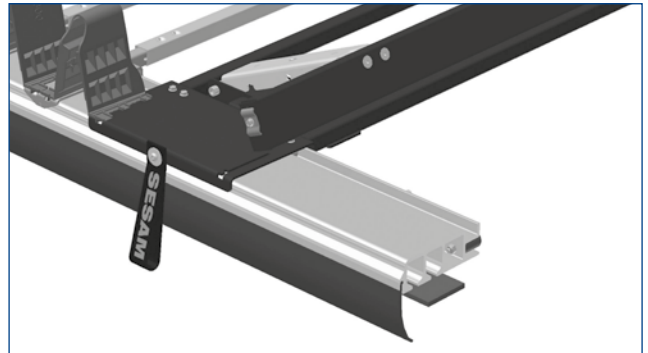

Leichtgängige Bedienung · *Smooth operation*

- Einfache Bedienung · *Easy handling*
- Geringer Kraftaufwand
Little effort required
- Entwickelt vom Pionier des Faltplattenverdecks
Developed by the pioneer of the folding panel roof



Festdach-Ausführung Flatliner-Fix *Fixed roof version Flatliner-Fix*

- Auf Anfrage
On request

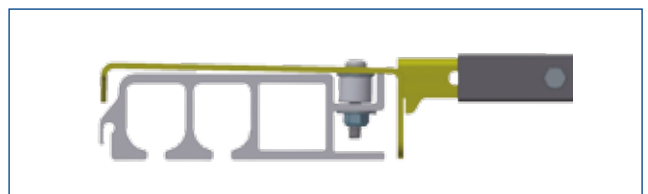



SESAM CS-FLATLINER



Dachaufbau / Roof structure

Besonderheiten · Characteristics

- Massiver Endlaufwagen aus Stahl · *Massive end carriage made of steel*
- Verprägte und kalibrierte Dachspiegel mit Querschnitt 30 x 30 mm
Embossed, calibrated roof bows with cross section 30 x 30 mm
- Flaches Dachgurtkonzept · *Flat roof strap concept*
- Robuste Faltplatten mit Einschubsystem · *Robust folding plates with slide-in system*
- Spiegel mit 692 mm Spriegelabstand · *Bow with 692 mm bow spacing*
- Optional auch mit 592 mm Spriegelabstand
Optionally also with 592 mm bow spacing



kurzes Verdeck-Paket / short roof-package



Robuste Gelenke mit Einschubsystem und Bohrung für Expanderseil (XL-Seile ragen nicht in den Laderaum)
Robust joints with insert system and drill holes for expander cable (XL cables do not protrude into cargo space)

Gelenkpaket · Joint Package

- < 1,4 m Paketlänge bis 8 m Aufbau
< 1.4 m package length up to 8 m body
- < 1,8 m Paketlänge bis 11 m Aufbau
< 1.8 m package length up to 11 m
- Pakethöhe ca. 280 mm
Package height approx. 280 mm

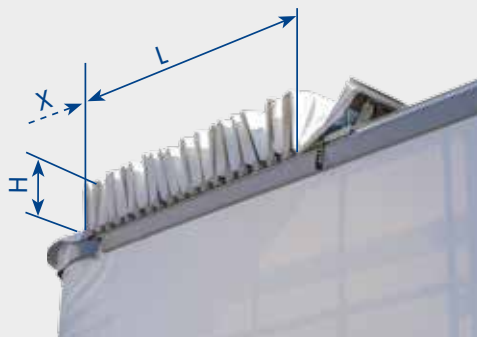

Länge **L**: ≈ 1,4 m - 1,8 m
*Length **L**: ≈ 1.4 - 1.8 m*

Höhe **H**: ≈ 300 mm
*Height **H**: ≈ 300 mm*

X = Maß bis Stirnwand
(kundenspezifisch)
X = Size up to bulkhead
(customer specific)

Flatliner · Flatliner 2550mm Standard

Profil · Profile

Alu-Träger · *Aluminum beam*

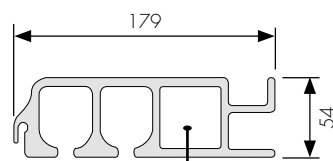

Kammer zur Aufnahme von Verstärkungsrohren
Chamber for reinforcement tubes

Verdeckaufbau · Roof Structure

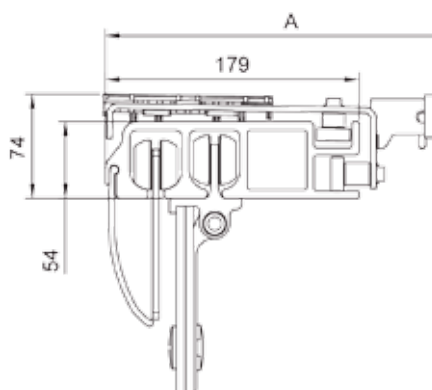

Gewicht · *Weight*
8,5 kg/m

Trägheitsmomente
Moments of inertia

$I_x = 119,9 \text{ cm}^4$
 $I_y = 868,4 \text{ cm}^4$



SESAM CS-FLATLINER



Dachkomponenten · Roof parts

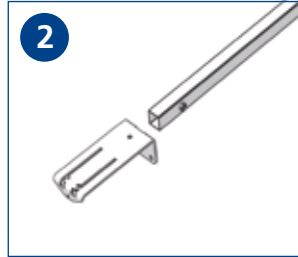
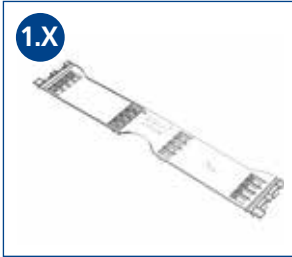

Zubehör · Roof accessories

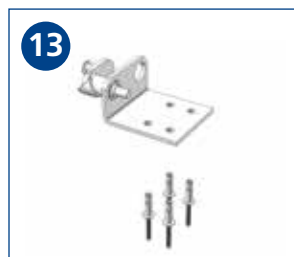
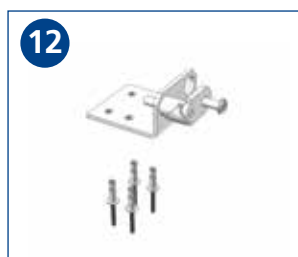
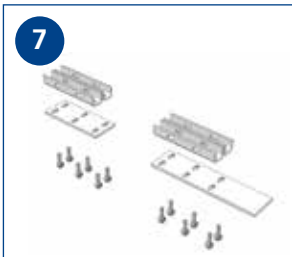



SESAM CS-FLATLINER



Dachkomponenten · Roof parts

Pos.	Artikel Article No.	Beschreibung Description Description	Verpackungseinheit Packet unit		Einzel Single C
			Groß Big A	Klein Small B	
1.1	194258700	Faltplatte Type 2 L=700 mm Folding plate 692mm	1000	500	1
1.2	194258600	Faltplatte Type 2 L=600 mm Folding plate 592mm		500	1
1.3	194258500	Faltplatte Type 2 L=500mm Folding plate 492mm		40	1
1.4	194258400	Faltplatte Type 2 L = 400 mm Folding plate 392mm		40	1
2	192332550	Verschraubte Dachspriegel SB:2550mm Screwed roofsticks, SB:2550mm		250	1
3	210332550	Endlaufteil L=53 SB:2550 Moving part, with lip 53mm		10	1
4	203332550	Portalbalken 80x40T3 SB:2550 Box beam 130mm		10	1
5	38062430	Zugstange Tie rod	125	10	1
6	235330020	Satz mit Zubehör EC4 Accessory Kit		10	1

Zubehör · Roof accessories

Pos.	Artikel Article No.	Beschreibung Description Description	Verpackungseinheit Packet unit		Einzel Single B
			Klein Small A		
7	220330010	Montagesatz Mounting Kit	10		1
8	242252250	Planenroller Side curtain rollers	500		1
9	250280035	Rungenlaufwagen Pillar bracket	48		1
10	250250003	Montageplatte für Rungenlaufwagen Mounting plate for pillar bracket	10		1
11	243250200	Profildichtung Rubber pelmet	20		1
12	235250010	Verriegelung für Klappfedermechanismus links Kit locking collapsible hinge left	10		1
13	235250011	Verriegelung für Klappfedermechanismus rechts Kit locking collapsible hinge right	10		1



SESAM CS-FLATLINER



Konfiguration bei Dachspriegelabstand 700 mm
 Configuration for roofstick distance of 700 mm

Basis · Basis Faltplatte Folding plate 700 mm	Gewicht Weight ~ kg/ St./pc.	Aufbaulänge/Trägerlänge · Structural length (mm)									
		4031 bis/till 4722	4723 bis/till 5414	5415 bis/till 6106	6107 bis/till 6798	6799 bis/till 7490	7491 bis/till 8182	8183 bis/till 8874	8875 bis/till 9566	9567 bis/till 10258	10259 bis/till 10950
Spiegel <i>Roofstick</i>											
192330255 2550 mm Flatliner	4,5	6	7	8	9	10	11	12	13	14	15
Endlaufteil <i>Moving part</i>											
210332550 2550 mm Flatliner	20,0	1	1	1	1	1	1	1	1	1	1
Portalbalken <i>Box section</i>											
203332550 80*40*2550 mm Flatliner	14,6	1	1	1	1	1	1	1	1	1	1
Faltplatten <i>Folding plate</i>											
194258700 692 mm	0,2	12	14	16	18	20	22	24	26	28	30
194258500 492 mm	0,2										
194258400 392 mm	0,1										
Zugstange <i>Tie rod</i>											
38062430	3,0	1	1	1	1	1	1	1	1	1	1
Zubehörsatz <i>Accessory kit</i>											
235330020	3,5	1	1	1	1	1	1	1	1	1	1



SESAM CS-FLATLINER



Konfiguration bei Dachspriegelabstand 600 mm
 Configuration for roofstick distance of 600 mm

Basis - Basis Faltplatte Folding plate 700 mm	Gewicht Weight ~ kg/ St./pc.	Aufbaulänge/Trägerlänge · Structural length (mm)									
		4031 bis/till 4722	4723 bis/till 5414	5415 bis/till 6106	6107 bis/till 6798	6799 bis/till 7490	7491 bis/till 8182	8183 bis/till 8874	8875 bis/till 9566	9567 bis/till 10258	10259 bis/till 10950
Spiegel <i>Roofstick</i>											
192330255 2550 mm Flatliner	4,5	6	7	8	9	10	11	12	13	14	15
Endlaufteil <i>Moving part</i>											
210332550 2550 mm Flatliner	20,0	1	1	1	1	1	1	1	1	1	1
Portalbalken <i>Box section</i>											
203332550 80°40°2550 mm Flatliner	14,6	1	1	1	1	1	1	1	1	1	1
Faltplatten <i>Folding plate</i>											
194258700 692 mm	0,2										
194258500 492 mm	0,2	12	14	16	18	20	22	24	26	28	30
194258400 392 mm	0,1										
Zugstange <i>Tie rod</i>											
38062430	3,0	1	1	1	1	1	1	1	1	1	1
Zubehörsatz <i>Accessory kit</i>											
235330020	3,5	1	1	1	1	1	1	1	1	1	1



FLATLINER

Komponenten · Parts

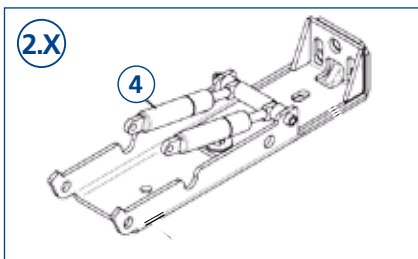
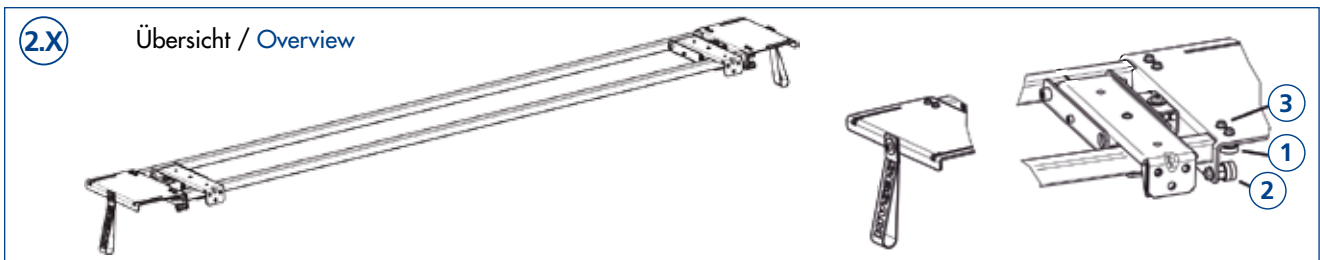
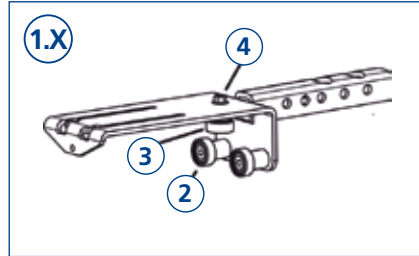
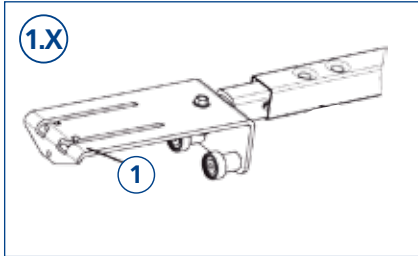



Pos.	Artikel Article No.	Beschreibung Description
1.1	191333000	Rollenwagen, montiert <i>Assembled bracket</i>
1.2	120260001	Führungsroller einfach M6x30, Kunststoff <i>Synthetic roller M6x30 plastic</i>
1.3	120260002	Führungsroller verkürzt, Kunststoff <i>Synthetic roller M6x23 plastic</i>
1.4	8717	Bolzen Tensilock M6x16 10.9 elv <i>Bolt Tensi-lock 10.9, zinc-plated M6*16</i>
2.1	120250002	Rolle verkürzt Lager M6x23,5 m. 1x609zz <i>Roller M6x23,5, double bearing</i>
2.2	120250007	Doppelrolle M8x28 <i>Roller M8x28, double bearing</i>
2.3	8717	Bolzen Tensilock M6x16 10.9 elv <i>Bolt Tensi-lock 10.9, zinc-plated M6*16</i>
2.4	130250600	Gasdruckfeder 600 N Hub +/-40mm CC:157mm <i>Gaspring 600N</i>



FLATLINER

Komponenten · Parts

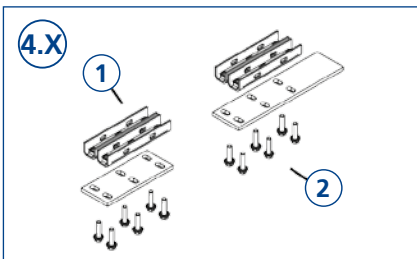
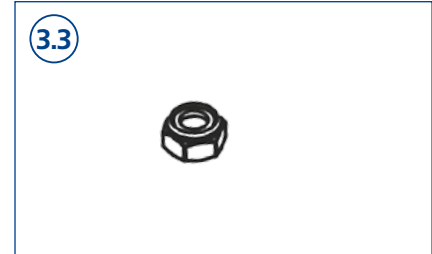
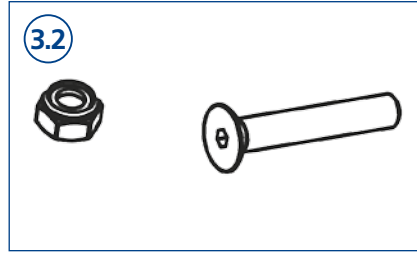
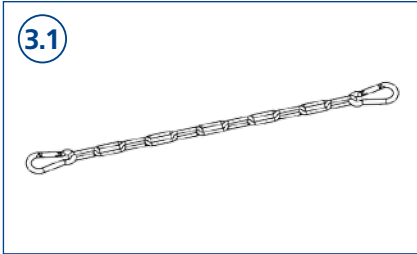



Pos.	Artikel Article No.	Beschreibung Description
3.1	8820	Spannkette L=500mm mit 2 Karabinerhaken <i>Chain Lg=500mm with 2 spring hooks</i>
3.2	235250019	Satz für Befestigung Portalbalken <i>Fixation materials box beam</i>
3.3	400079459	Sicherungsmutter M8 DIN985 zn <i>Self-locking screw M8 DIN 985 vz</i>
4.1	220252003	Klemmplatte 3xM10 <i>Mounting bar 190x35x31mm, with 3 bolts M10</i>
4.2	140250025	Schraube M10x40 <i>Bolt M10x40 Tensilock DIN6921</i>



European Trailer Systems GmbH

Im Moerser Feld 1f, 47441 Moers, Germany

Phone: +49 (0) 2841 6070 700 · Fax: +49 (0) 2841 6070 333

www.EdschaTS.com

Member of VBG GROUP

